

RULON ACOUSTICAL CEILING SYSTEM

ALURATONE 700

ARCHITECTURAL SPECIFICATIONS

PART 1 - GENERAL

- A. The Rulon Aluratone Ceiling Systems covered by this specification shall be the products of the Rulon International, World Commerce Center, 2000 Ring Way Road, St. Augustine, FL 32092. Phone: 800-227-8566, 904-584-1400, Fax: 904-584-1499, www.rulonco.com.
- B. The General Conditions and the requirements of Division 1 of the specifications shall apply to all work hereunder.
- C. All work shall be performed in accordance with the manufacturer's instructions, and in a manner satisfactory to the owner's representative.

1.01 SCOPE

- A. Rulon International shall furnish all Rulon Wood Veneer Acoustical Ceiling Panel assemblies necessary to complete installation by the contractor, in accordance with plans and specifications. Heavy duty 15/16" (24mm) T-rails, as required, shall be supplied by the contractor.

1.02 RELATED WORK NOT INCLUDED UNDER THIS SECTION

- A. Suspension systems and components for ceilings other than the manufacturers Aluratone ceiling system are not included.

1.03 QUALITY ASSURANCE

- A. **Installer Qualifications:** The installer shall be a firm with a minimum of two (2) years of successful experience in installation of products with similar requirements to this project. The installer shall be acceptable to the architect, manufacturer, and owner's representative.
- B. **Fire Performance Characteristics:** When specified as "Fire Resistant", Rulon Aluratone Acoustical Ceiling Panels shall conform to Class 1, or A flame spread rating, when tested according to ASTM E-84.
- C. **Environmental Standards:** When required, veneer panel components shall originate from well managed forests as certified by accredited and recognized industry certifying organizations.

1.04 PROJECT CONDITIONS

- A. Installation shall be done only when the temperature and humidity closely approximate the interior conditions that will exist when the building is occupied. The heating and cooling systems shall be operating before, during, and after installation, with the humidity of the interior spaces maintained between 25% and 55%, temperature between 60 to 90 degrees F.
- B. It is important that area have proper ventilation, especially in high moisture areas. There shall be no excessive build up of heat in the space.
- C. Prior to the start of installation, all exterior windows and doors are to be in place, glazed, and weather-stripped. The roof is to be watertight, and all wet trades' work is to be completed, and thoroughly dry.
- D. Mechanical, electrical, and other utility service installations behind the ceiling plane shall have been completed. No materials should rest, wrap around, or be supported by the ceiling suspension components or connecting hangers. .

1.05 COORDINATION OF WORK

- A. The layout and installation of Rulon Aluratone Wood Veneer Acoustical Ceiling Panels shall be coordinated with other work penetrating the ceiling. This includes light fixtures or junction boxes, HVAC equipment, and fire protection components.

1.06 SUBMITTALS

- A. Product Data: Rulon International shall provide product specifications and installation instructions for all supplied materials.
- B. Shop Drawings: When required, Rulon International shall supply shop drawings showing Rulon Wood Veneer Ceiling Panel sizes and locations, and other details deemed pertinent to proper installation.
- C. Samples: A 12" (305mm) wide x 12" (305mm) long sample, with finish applied, shall be submitted for approval.

1.07 DELIVERY, STORAGE, AND HANDLING

- A. Rulon Wood Veneer Acoustical Ceiling Panel assemblies shall be delivered to the project site in original, unopened packages.
- B. The Rulon Ceiling Panels shall be stored in a fully enclosed space, for a minimum of seventy-two (72) hours immediately prior to ceiling installation. The Rulon Ceiling Panels shall be stored in the room in which they will be installed. The temperature and humidity of the room shall closely approximate those conditions that will exist when the building is occupied. The Rulon Ceiling Panels shall be stored off the floor.

- C. Care in handling must be exercised to avoid damage.

1.08 WARRANTIES

- A. Manufacturer: All materials supplied by the Ceiling Panel manufacturer shall be guaranteed against manufacturing defects for one (1) year. Because of differing site conditions, wood stains and colorings can vary with age and are excluded from this warranty.
- B. Contractor: All work shall be guaranteed for one (1) year from final acceptance of completed work.

PART 2 - PRODUCT

2.01 CEILING PANELS

- A. The acoustical ceiling panels shall be manufactured by Rulon International, St. Augustine, Florida, PH-1-800-227-8566, 904-584-1400. Panels shall be factory-fabricated to sizes established by approved Rulon shop drawings and confirmed by field dimensions. The Rulon Aluratone Acoustical Ceiling Panels will be made with a [veneer species] face veneer, [veneer cut] [veneer match], applied to a 3/4" (19mm) thick core material with perforations through the panel. The size and location of the face perforations may be altered to match project-specific requirements. Acoustical absorptive black backing is applied in the factory. Wood is a natural product that will undergo changes with variations in the environment. Therefore, all dimension tolerances are $\pm 1/8"$ (3mm).

2.02 SUSPENSION SYSTEMS

- A. The ceiling panels shall be suspended from standard heavy duty 15/16" (24mm) T-rail (supplied by contractor) using torsion springs, C-hangers, or direct screw attachment, according to project design.

2.03 EDGES, BORDERS, AND PERIMETER TRIMS

- A. Edges, borders and perimeter trims shall be designated by the specifier in accordance with standard design details available. All wood ceiling products specified shall be supplied by the ceiling manufacturer.

2.04 FINISHES AND COLORS

- A. The Aluratone Acoustical Panel face and edge surfaces shall be factory finished with a clear or custom stain as selected by the Architect. Wood is a natural product with variations in grain, texture and color – often ranging from light to dark – thereby affecting the surface look. Product finishes shall be stain or sealer coats – spray applied to a smooth sanded surface.

PART 3 - EXECUTION

3.01 PREPARATION

- A. Ceiling Layout: If required, prior to manufacture, field dimensions shall be taken to determine Panel sizes. The contractor shall measure applicable areas prior to installation to confirm application and location of Panel supports, in accordance with installation instructions.
- B. Coordination: The contractor shall furnish the layout for supports that shall be installed for suspension of ceilings. He shall furnish concrete inserts, steel deck hanger clips, or similar devices for installation, in time to coordinate the work. The contractor shall coordinate with other trades the location of devices which will penetrate the Ceiling Panels or interfere with the installation. Recessed or surface devices located within the ceiling panels are to be located and cut in the field.

3.02 INSTALLATION

- A. General: The contractor shall install materials in accordance with Rulon International printed instructions and architect's drawings. The installation shall comply with applicable regulations and industry standards.

3.03 ADJUSTMENT, CLEANING, AND REPAIR

- A. The contractor shall make final adjustments to level and/or contours.
- B. Upon completion of installation, all Rulon Acoustical Ceiling Panels shall be cleaned free of dirt, dust, grease, oils and fingerprints.
- C. All work which cannot be successfully cleaned or repaired shall be removed and replaced.

3.04 INSPECTION

- A. Upon completion of installation, the owner's representative shall inspect all finished surfaces to ensure that work has been performed in a manner satisfactory to the owner. Any deficiencies in the installed Ceiling Panels shall be corrected by the contractor at no additional cost to the owner, or to the manufacturer.

RULON ACOUSTICAL WALL SYSTEM

ALURATONE 700

ARCHITECTURAL SPECIFICATIONS

PART 1 - GENERAL

- A. The Rulon Aluratone Wall Systems covered by this specification shall be the products of the Rulon International, World Commerce Center, 2000 Ring Way Road, St. Augustine, FL 32092. Phone: 800-227-8566, 904-584-1400, Fax: 904-584-1499, www.rulonco.com.
- B. The General Conditions and the requirements of Division 1 of the specifications shall apply to all work hereunder.
- C. All work shall be performed in accordance with the manufacturer's instructions, and in a manner satisfactory to the owner's representative.

1.01 SCOPE

- A. Rulon International shall furnish all Rulon Panel assemblies necessary to complete installation by the contractor, in accordance with plans and specifications.

1.02 RELATED WORK NOT INCLUDED UNDER THIS SECTION

- A. Attachment systems and components for walls other than the manufacturer's Aluratone wall system are not included.

1.03 QUALITY ASSURANCE

- A. **Installer Qualifications:** The installer shall be a firm with a minimum of two (2) years of successful experience in installation of products with similar requirements to this project. The installer shall be acceptable to the architect, manufacturer, and owner's representative.
- B. **Fire Performance Characteristics:** When specified as "Fire Resistant", the Rulon Aluratone Acoustical Wall Panels shall conform to Class 1, or A flame spread rating, when tested according to ASTM E-84.
- C. **Environmental Standards:** When required, veneer panels components shall originate from well managed forests as certified by accredited and recognized industry certifying organizations.

1.04 PROJECT CONDITIONS

- A. Installation shall be done only when the temperature and humidity closely approximate the interior conditions that will exist when the building is occupied. The heating and cooling systems shall be operating before, during, and after installation, with the humidity of the interior spaces maintained between 25% and 55%, temperature between 60 to 90 degrees F.
- B. It is important that area have proper ventilation, especially in high moisture areas. There shall be no excessive build up of heat in the space.
- C. Prior to the start of installation, all exterior windows and doors are to be in place, glazed, and weather-stripped. The roof is to be watertight, and all wet trades' work is to be completed, and thoroughly dry.
- D. Mechanical, electrical, and other utility service installations behind the wall plane shall have been completed. No materials should rest, wrap around, or be supported by the wall suspension components.

1.05 COORDINATION OF WORK

- A. The layout and installation of Rulon Aluratone Acoustical Wall Panels shall be coordinated with other work penetrating the wall.

1.06 SUBMITTALS

- A. Product Data: Rulon International shall provide product specifications for all supplied materials.
- B. Shop Drawings: When required, Rulon International shall supply shop drawings showing Rulon Wood Veneer Wall Panel sizes and locations, and other details deemed pertinent to proper installation.
- C. Samples: A 12" (305mm) wide x 12" (305mm) long sample, with finish applied, shall be submitted for approval.

1.07 DELIVERY, STORAGE, AND HANDLING

- A. Rulon Wood Veneer Acoustical Wall Panels shall be delivered to the project site in original, unopened packages.
- B. The Rulon Wall Panels shall be stored in a fully enclosed space, for a minimum of seventy-two (72) hours immediately prior to installation. The Rulon Wall Panels shall be stored in the room in which they will be installed. The temperature and humidity of the room shall closely approximate those conditions that will exist when the building is occupied. The Rulon Wall Panels shall be stored off the floor.
- C. Care in handling must be exercised to avoid damage.

1.08 WARRANTIES

- A. Manufacturer: All materials supplied by the wall panel manufacturer shall be guaranteed against manufacturing defects for one (1) year. Because of differing site conditions, wood stains and colorings can vary with age and are excluded from this warranty.
- B. Contractor: All work shall be guaranteed for one (1) year from final acceptance of completed work.

PART 2 - PRODUCT

2.01 WALL PANELS

- A. The acoustical wall panels shall be manufactured by Rulon International, St. Augustine, Florida, PH-1-800-227-8566, 904-584-1400. Panels shall be factory-fabricated to sizes established by approved Rulon shop drawings and confirmed by field dimensions. The Rulon Aluratone Acoustical Wall Panels will be made with a [veneer species] face veneer, [veneer cut] [veneer match], applied to a 3/4" (19mm) thick core material with perforations through the panel. The size and location of the face perforations may be altered to match project-specific requirements. Acoustical absorptive black backing is applied in the factory. Wood is a natural product that will undergo changes with variations in the environment. Therefore, all dimension tolerances are $\pm 1/8"$ (3mm).

2.02 ATTACHMENT SYSTEMS

- A. The wall panels shall be installed using Rulon-supplied Z-clips or other approved attachment devices.

2.03 EDGES, BORDERS, and PERIMETER TRIMS

- A. Edges, borders and perimeter trims shall be designated by the specifier in accordance with standard design details available. All wood wall products specified shall be supplied by the wall manufacturer.

2.04 FINISHES AND COLORS

- A. The Aluratone Acoustical Panel face and edge surfaces shall be factory finished with a clear or custom stain as selected by the Architect. Wood is a natural product with variations in grain, texture and color – often ranging from light to dark – thereby affecting the surface look. Product finishes shall be stain or sealer coats – spray applied to a smooth sanded surface.

PART 3 - EXECUTION

3.01 PREPARATION

- A. Wall Layout: When required, prior to manufacture, field dimensions shall be taken to determine Panel sizes. The contractor shall measure applicable areas prior to installation to confirm application and location of Panel supports, in accordance with installation instructions.
- B. Coordination: The contractor shall coordinate with other trades the location of devices which will penetrate the wall panels or that may interfere with the installation. Recessed or surface devices located within the wall panels are to be located and cut in the field.

3.02 INSTALLATION

- A. General: The contractor shall install materials in accordance with generally accepted procedures (AWI) for wood veneer wall panels and architect's drawings. The installation shall comply with applicable regulations and industry standards.

3.03 ADJUSTMENT, CLEANING, AND REPAIR

- A. The contractor shall make final adjustments to level and/or contours.
- B. Upon completion of installation, all Rulon Acoustical Wall Panels shall be cleaned free of dirt, dust, grease, oils and fingerprints.
- C. All work which cannot be successfully cleaned or repaired shall be removed and replaced.

3.04 INSPECTION

- A. Upon completion of installation, the owner's representative shall inspect all finished surfaces to ensure that work has been performed in a manner satisfactory to the owner. Any deficiencies in the installed wall panels shall be corrected by the contractor at no additional cost to the owner, or to the manufacturer.

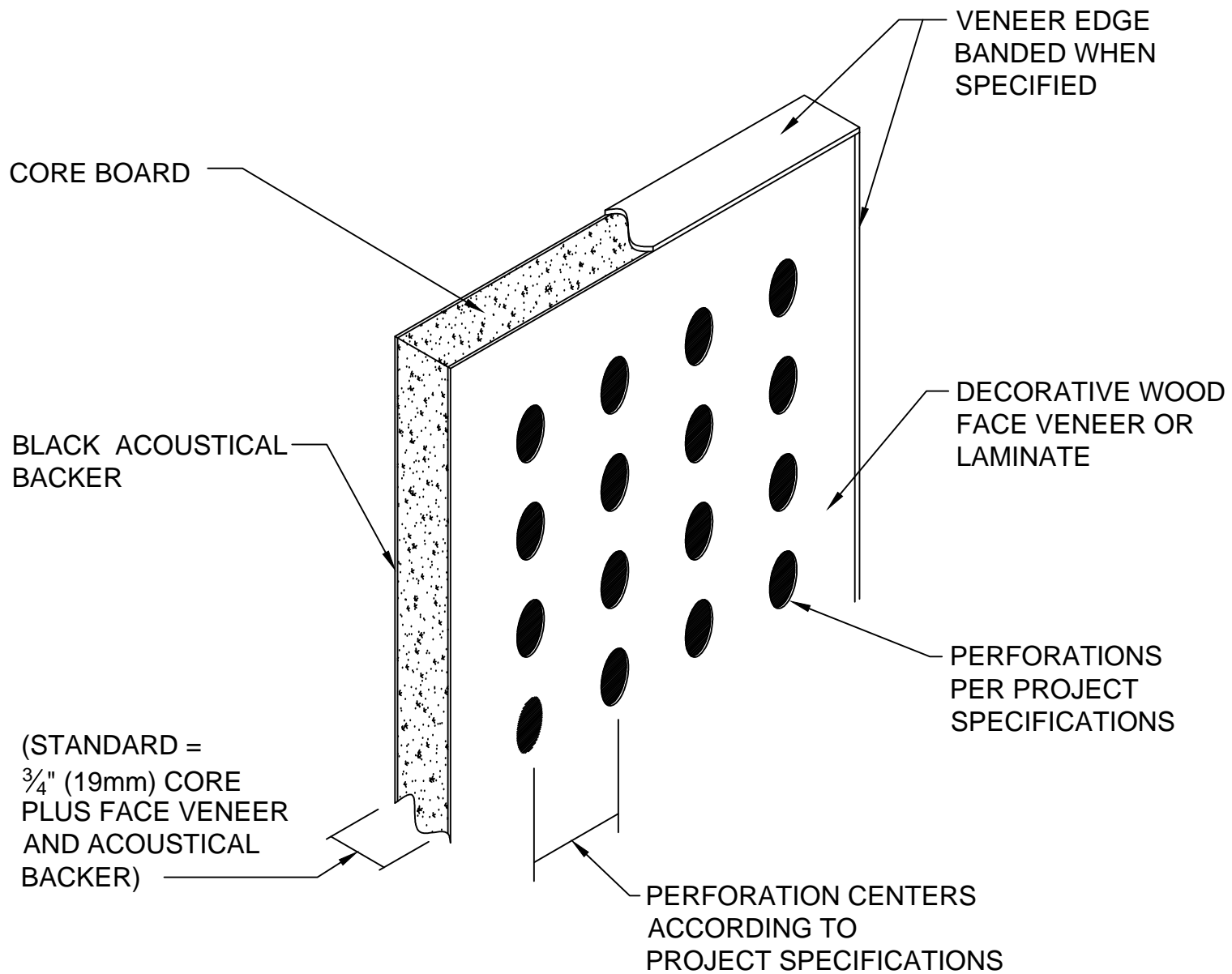

RULON INTERNATIONAL

World Commerce Center
 2000 Ring Way Road
 St. Augustine, FL 32092
 Ph: 1-800-227-8566
 904-584-1400
 Fax: 904-584-1499
 www.rulonco.com
 info@rulonco.com

PROJECT:

TITLE:

Aluratone 700 Panel - Isometric View

ISSUE DATE:

REVISION DATE:

AUG/10/2016

DRAWN BY:

CAP

CHECKED BY:

TA

PROJECT NUMBER:

DRAWING NUMBER:

A7AS0007

16mm Straight Centers

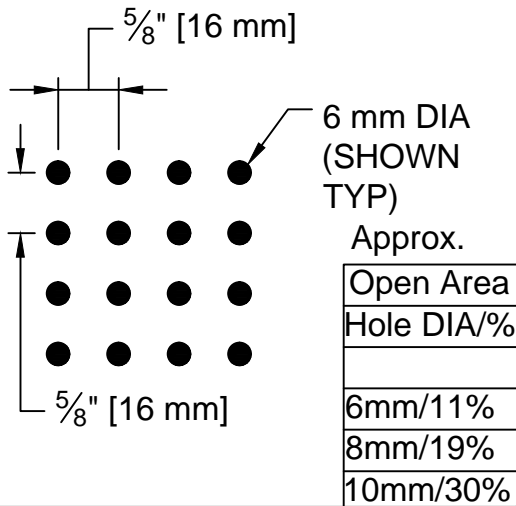

16mm Staggered

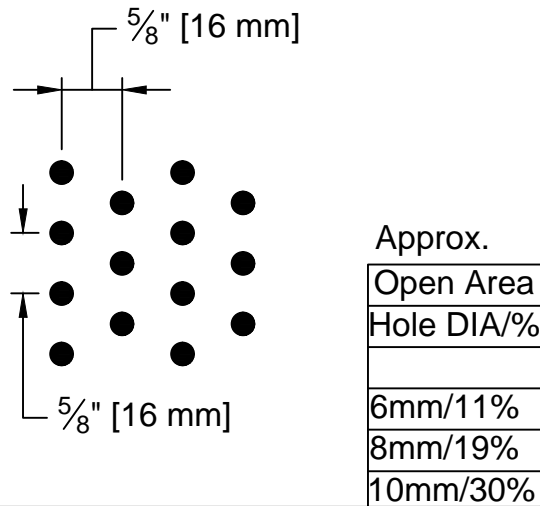

16mm Diagonal Centers

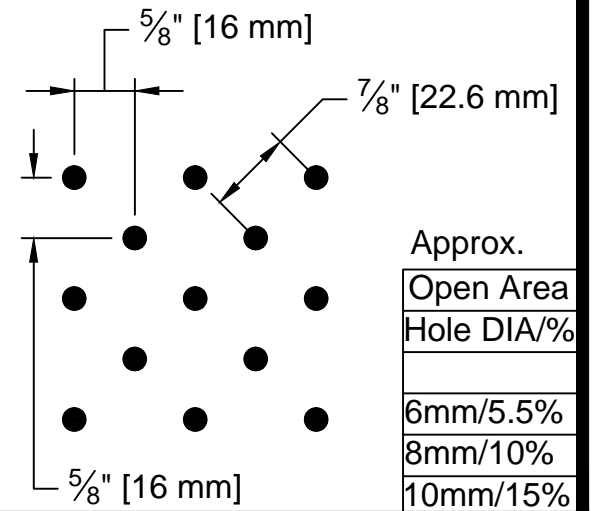

32mm Straight Centers

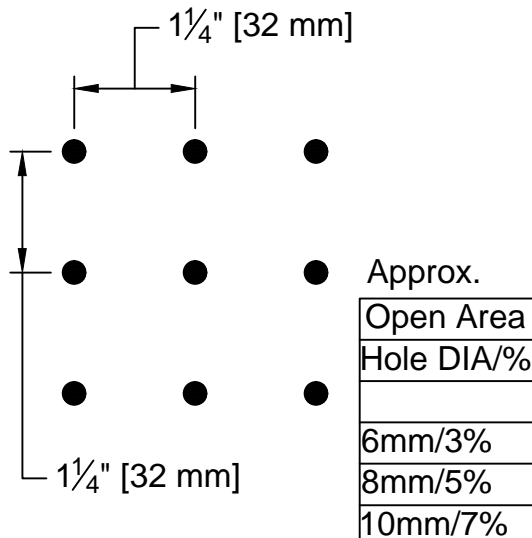

32mm Staggered Centers

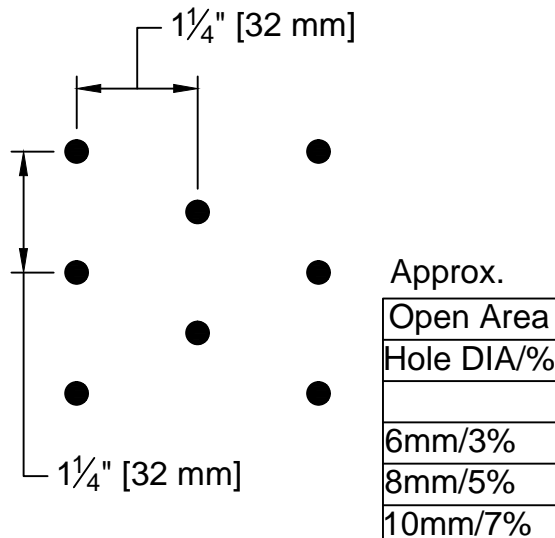

32mm Diagonal

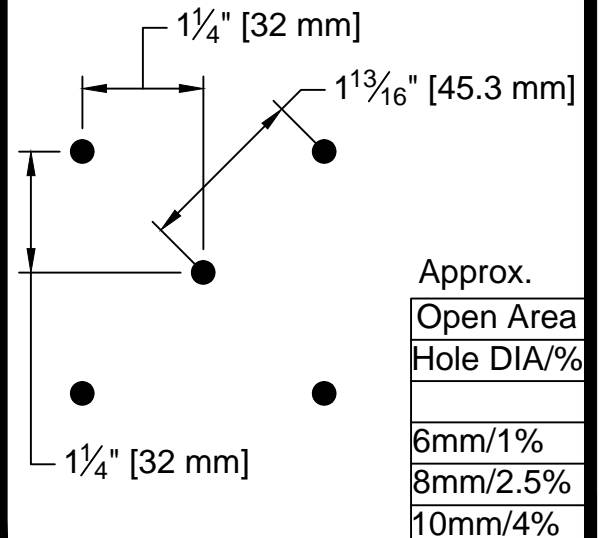

RULON INTERNATIONAL

World Commerce Center
 2000 Ring Way Road
 St. Augustine, FL 32092
 Ph: 1-800-227-8566
 904-584-1400
 Fax: 904-584-1499
 www.rulonco.com
 info@rulonco.com

PROJECT:

TITLE:

Aluratone 700 Typical
 Perforations Detail

1/2 SCALE

REVISION DATE:

SEP/13/2012

DRAWN BY:

CAP

CHECKED BY:

TDA

PROJECT NUMBER:

DRAWING NUMBER:

A7AS0008

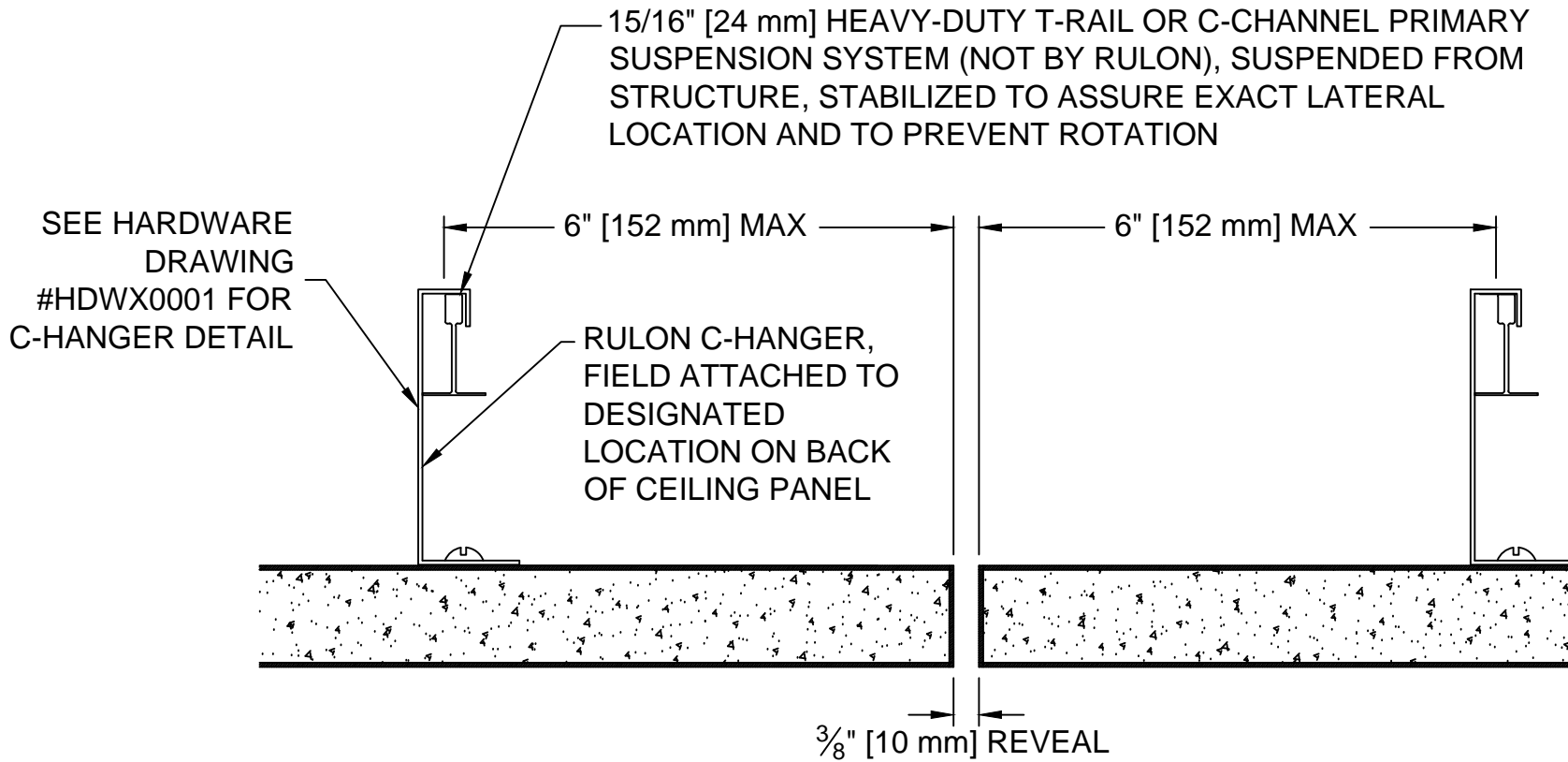

RULON INTERNATIONAL

World Commerce Center
 2000 Ring Way Road
 St. Augustine, FL 32092
 Ph: 1-800-227-8566
 904-584-1400
 Fax: 904-584-1499
 www.rulonco.com
 info@rulonco.com

PROJECT:

TITLE:

C-Hanger Mounting Detail

ISSUE DATE:

REVISION DATE:

SEP/13/2012

DRAWN BY:

CAP

CHECKED BY:

TA

PROJECT NUMBER:

DRAWING NUMBER:

AXXX0011

NOTE:

SEE HARDWARE DRAWING
#HDWX002 FOR TORSION
SPRING ASSEMBLY DETAIL

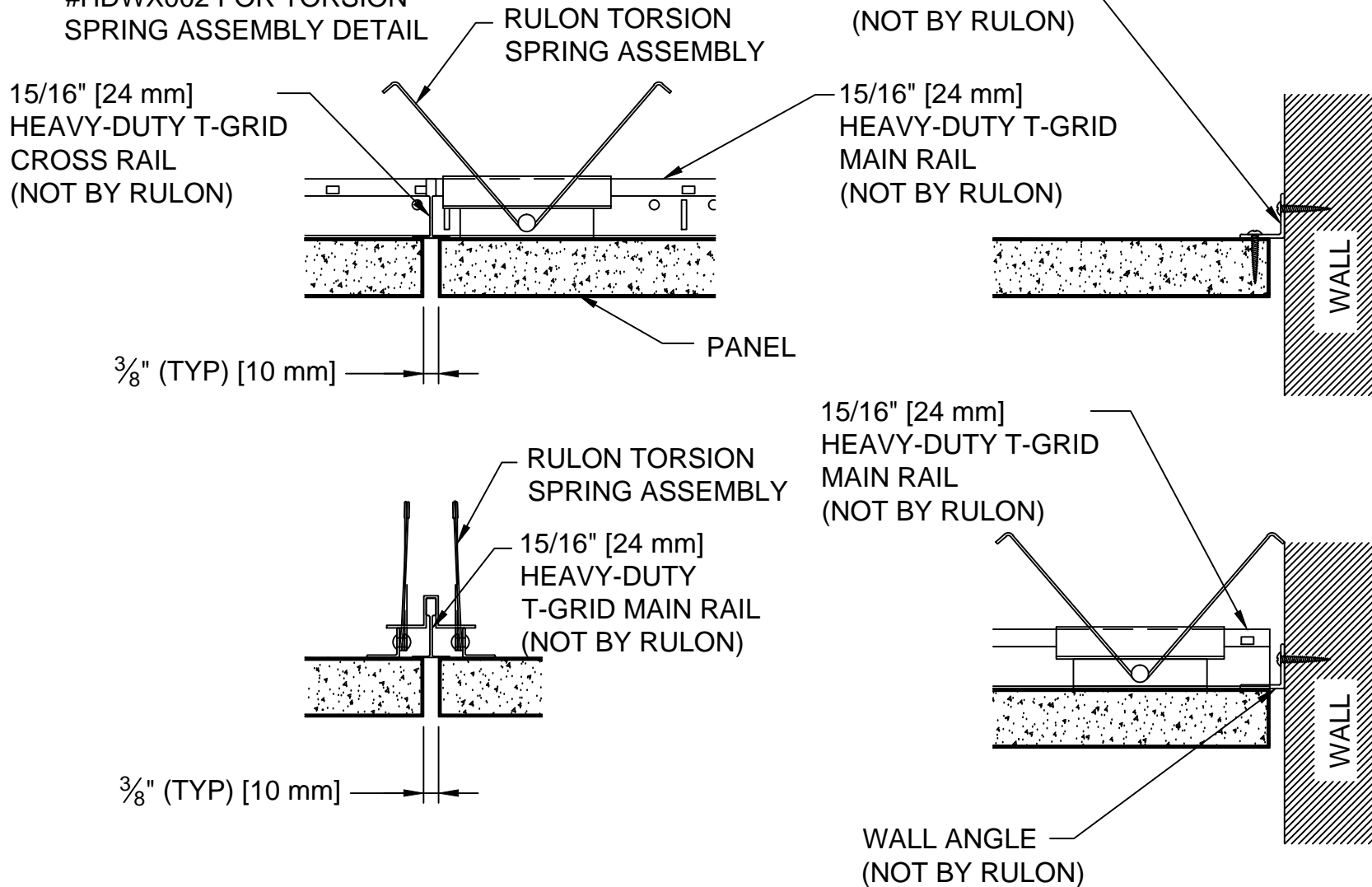

RULON INTERNATIONAL

World Commerce Center
2000 Ring Way Road
St. Augustine, FL 32092
Ph: 1-800-227-8566
904-584-1400
Fax: 904-584-1499
www.rulonco.com
info@rulonco.com

PROJECT:

TITLE: **Torsion Spring Mounting Detail -
Flush**

ISSUE DATE:

REVISION DATE:
SEP/13/2012

DRAWN BY:
CAP

CHECKED BY:
TA

PROJECT NUMBER:

DRAWING NUMBER:
AXXX0012

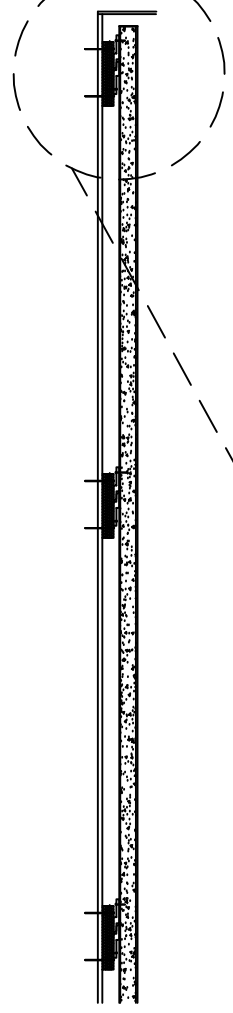

MATCHING
VENEER
EDGE BAND

RULON Z-CLIPS
FIELD INSTALLED

BLOCKING AS
NECESSARY
(BY OTHERS)

BALANCING
VENEER ON
BACK

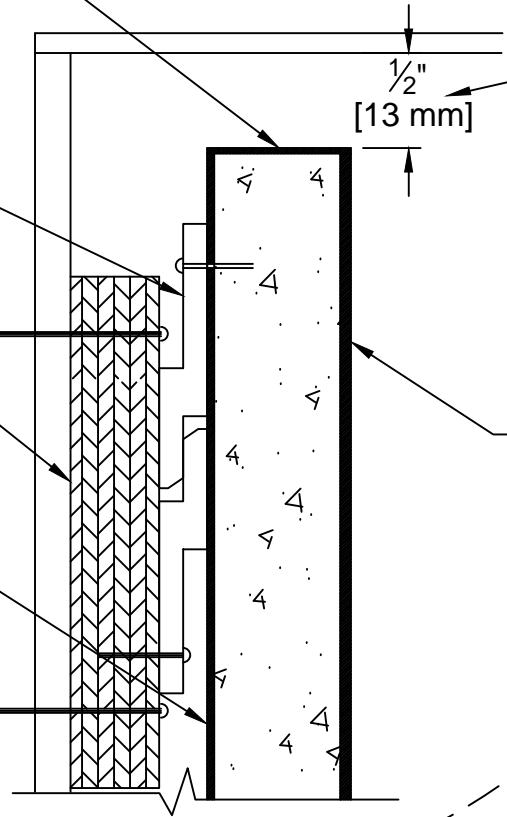

1/2"
[13 mm]

REQUIRED SPACE
TO INSTALL
PANELS (LIFT
PANEL AND
ENGAGE ONTO
Z-CLIPS)

RULON PANEL
FACE

NOTE:
SEE HARDWARE
DRAWING #HDWX0003
FOR Z-CLIP DETAIL



RULON INTERNATIONAL

World Commerce Center
2000 Ring Way Road
St. Augustine, FL 32092
Ph: 1-800-227-8566
904-584-1400
Fax: 904-584-1499
www.rulonco.com
info@rulonco.com

PROJECT:

TITLE: **Z-Clip Mounting Detail**

ISSUE DATE:

REVISION DATE:
SEP/13/2012

DRAWN BY:
CAP

CHECKED BY:
TA

PROJECT NUMBER:

DRAWING NUMBER:
AXXX0013

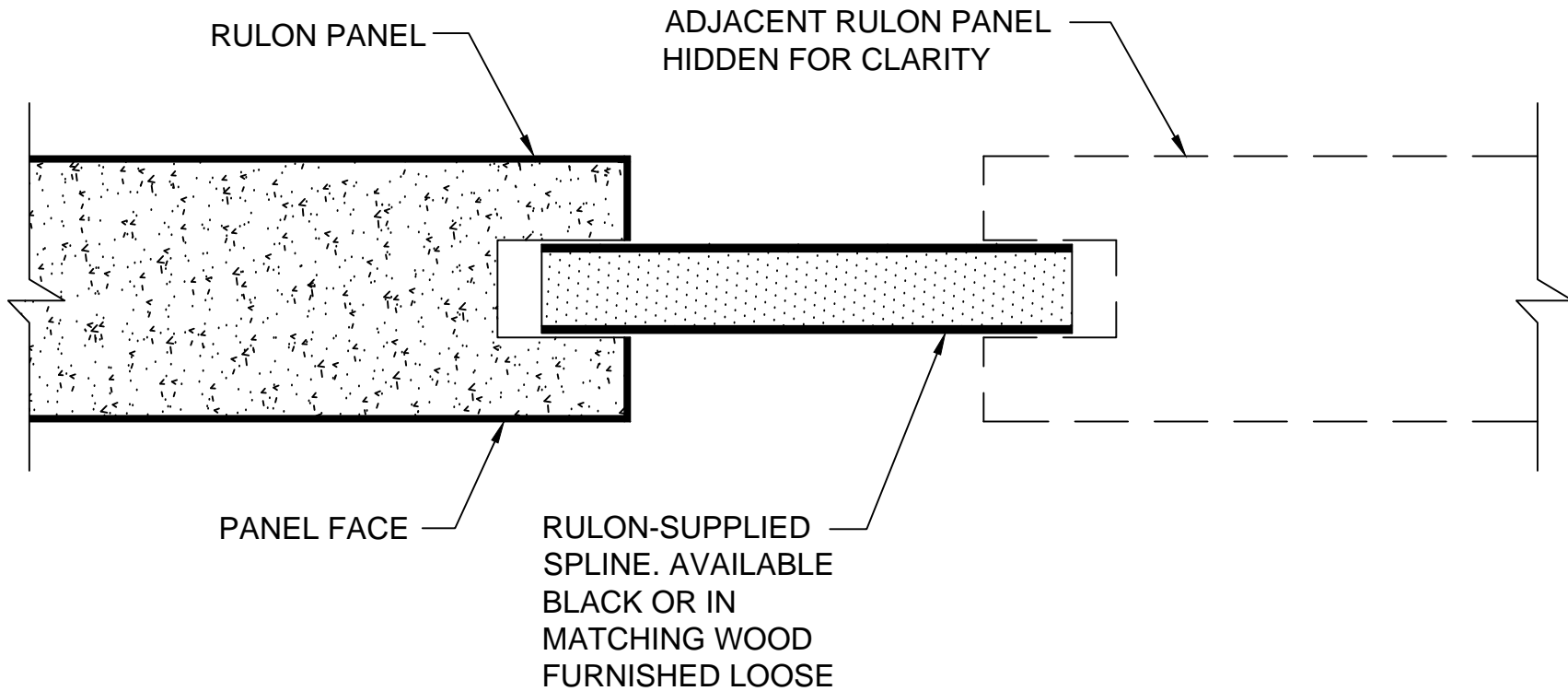

RULON INTERNATIONAL

World Commerce Center
 2000 Ring Way Road
 St. Augustine, FL 32092
 Ph: 1-800-227-8566
 904-584-1400
 Fax: 904-584-1499
 www.rulonco.com
 info@rulonco.com

PROJECT:

TITLE: **Side Spline Detail**

ISSUE DATE:

REVISION DATE:
SEP/13/2012

DRAWN BY:

CAP

CHECKED BY:

TA



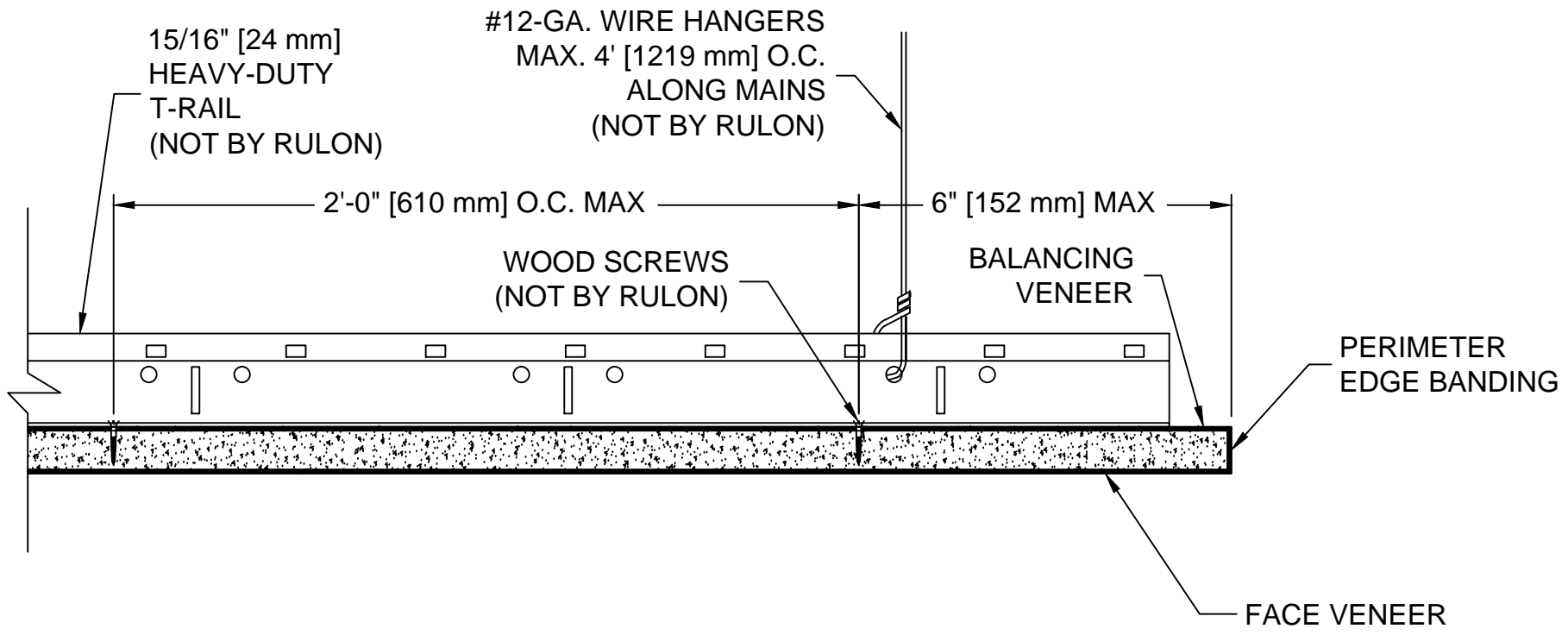

PROJECT NUMBER:

DRAWING NUMBER:

AXXX0014

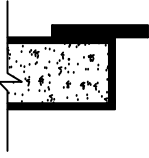
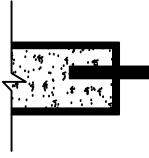

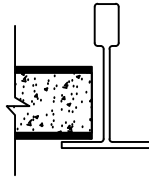
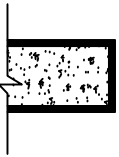
 <p>RULON INTERNATIONAL</p>	World Commerce Center 2000 Ring Way Road St. Augustine, FL 32092 Ph: 1-800-227-8566 904-584-1400 Fax: 904-584-1499 www.rulonco.com info@rulonco.com	PROJECT: TITLE: Direct Screw Ceiling Attachment Detail	ISSUE DATE: REVISION DATE: SEP/13/2012	DRAWN BY: CAP CHECKED BY: TA	PROJECT NUMBER: DRAWING NUMBER: AXXX0015

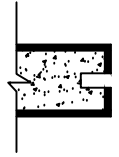
<p>Edge-banded Full Depth Tegular</p>	<p>Edge-banded Partial Depth Tegular</p>	<p>Standard Tegular</p>	<p>Lay-in</p>
 <p>Available for Ceilings: 15/16" [24 mm] Grid and 9/16" [14 mm] Grid</p>	 <p>Available for Ceilings: 15/16" [24 mm] GRID AND 9/16" [14 mm] GRID</p>	 <p>Available for Ceilings: 15/16" [24 mm] GRID AND 9/16" [14 mm] GRID</p>	 <p>Available for Ceilings: 15/16" [24 mm] GRID AND 9/16" [14 mm] GRID</p>
<p>Edge-banded</p>	<p>Edge-banded Side Slot</p>	<p>Edge-banded Side Spline</p>	<p>NOTES:</p> <p>1) Heavy Duty Grid Mains to be on Maximum 2' Centers</p> <p>2) These edge conditions apply to 3/4" [19 mm] Thick Panels only</p>
 <p>Available for: Walls and Ceilings (Direct attach, z-clips, C-Hangers, Torsion Springs, etc.)</p>	 <p>Available for Ceilings: 15/16" [24 mm] Grid</p>	 <p>Available for Walls: Accepts Black or Matching Wood Veneer Spline Spacer</p>	

 RULON INTERNATIONAL	<p>World Commerce Center 2000 Ring Way Road St. Augustine, FL 32092 Ph: 1-800-227-8566 904-584-1400 Fax: 904-584-1499 www.rulonco.com info@rulonco.com</p>	<p>PROJECT:</p>	<p>ISSUE DATE:</p>	<p>DRAWN BY: CAP</p>	<p>PROJECT NUMBER:</p>
		<p>TITLE: Edge Conditions Details</p>	<p>REVISION DATE: NOV/05/2014</p>	<p>CHECKED BY: TDA</p>	<p>DRAWING NUMBER: AXXX0016</p>